

PITMEC

THE PES 190 ECCENTRIC UNDERREAMING SYSTEM



CASING SIZE 219MM OD X 206MM ID DRILLING DIA. 238MM

PNEUMEC PES 190 ECCENTRIC UNDERREAMING SYSTEM

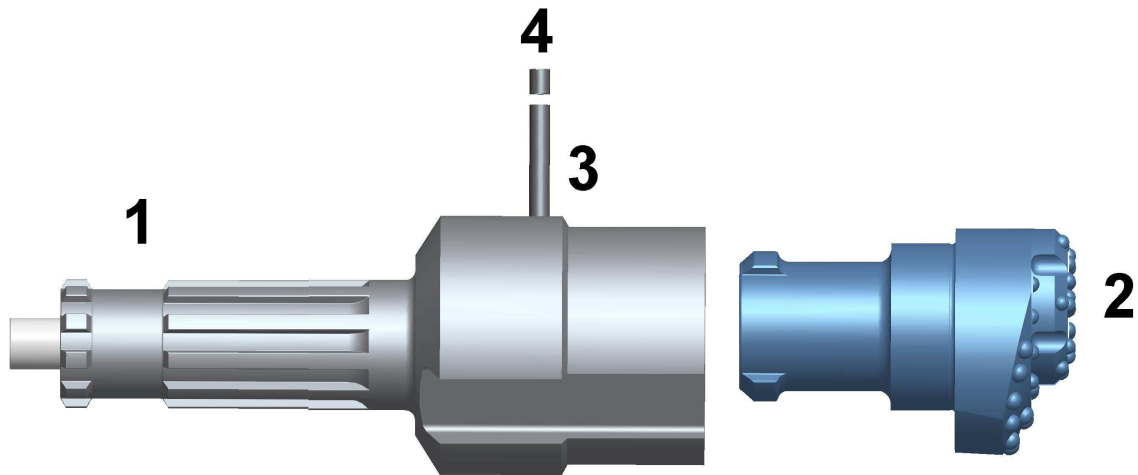

PES 190 PARTS LIST

1.	GUIDE DEVICE DHD360 SHANK	UGD190360PES
2.	ECCENTRIC BIT	UPB190PES
3.	LOCKING PIN	USP19050PES
4.	SPLIT PIN	USP19051PES
5.	COMPLETE SYSTEM	UCS190360PES

PES 190 SPECIFICATIONS

UPPER BODY DIAMETER	203MM	CLOSED DIAMETER	190MM
REAMING DIAMETER	238MM	CASING SIZE	219MM OD X 206MM ID
SYSTEM LENGTH	690MM	SYSTEM WEIGHT	105KG

PES 190 CASING SHOES

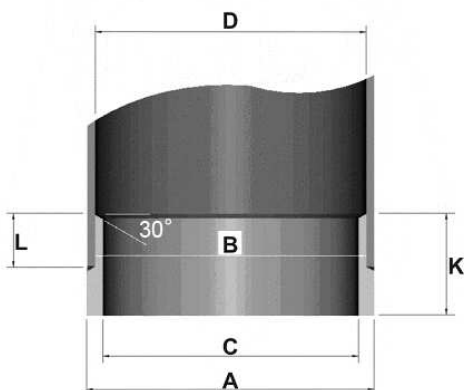

DIA. A	219MM
DIA. B	203MM
DIA. C	192MM
DIA. D	206MM
L	71MM
K	115MM

PNEUMEC

PNEUMEC COMPANY LIMITED

1st Floor, Tin On Sing Comm. Bldg., 41-43 Graham St. Central, H.K.

Tel : (852) 2180 9922

Website : www.pneumec.com

Fax : (852) 2180 9982

email : info@pneumec.com